

Pigoli



Anthology



<i>Agatha capitonné.....</i>	<i>2</i>
<i>Airone componibile.....</i>	<i>16</i>
<i>Alice pouf.....</i>	<i>9/29</i>
<i>Ambassador capitonné.....</i>	<i>32</i>
<i>Ducale.....</i>	<i>10</i>
<i>Etoile.....</i>	<i>36</i>
<i>Etoile-ring capitonné</i>	<i>34</i>
<i>Eva.....</i>	<i>24</i>
<i>Glicine.....</i>	<i>42</i>
<i>Glicine-ring componibile.....</i>	<i>46</i>
<i>Hermitage.....</i>	<i>28</i>
<i>Ibisco-ring.....</i>	<i>50</i>
<i>Kyoto.....</i>	<i>12</i>
<i>Kyoto capitonné.....</i>	<i>14</i>
<i>Marlene.....</i>	<i>26</i>
<i>Marlene-ring.....</i>	<i>22</i>
<i>Morfeo capitonné.....</i>	<i>48</i>
<i>Nives.....</i>	<i>53</i>
<i>Nives capitonné.....</i>	<i>52</i>
<i>Raphael.....</i>	<i>8</i>
<i>Segesta capitonné.....</i>	<i>38</i>

Agatha capitonné





Agatha capitonné





6 *Agatha* poltrona capitonnè



Agatha tavolino capitonnè



Raphael



Ducale



Kyoto





Kyoto capitonné





Airone componibile



18 *Airone* poltrona capitonné



Airone componibile



Marlene-ring



Eva



Marlene-ring





Marlene



Alice pouf

Hermitage

Hermitage





*A*mbassador capitonné

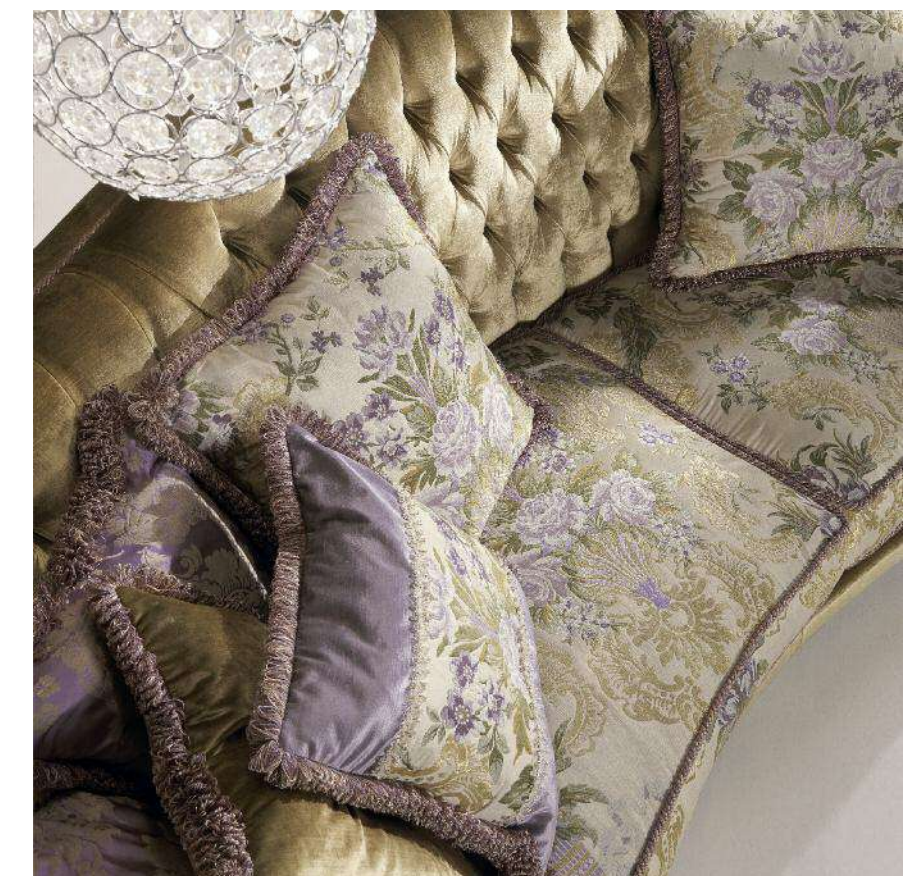

Etoile-ring capitonné





Segesta capitonné





Glicine



Glicine





*G*licine-ring componibile

Morfeo capitonné





*I*bisco-ring

Nives capitonné



Nives

Nozioni tecniche

La produzione di ogni articolo originale delle collezioni Pigoli Salotti è caratterizzata dai più alti standards qualitativi, tipici della migliore lavorazione artigianale che prevede l'impiego esclusivo di materie prime selezionate, garantite nell'affidabilità tecnologica per assicurarne una lunga durata nel tempo.

Ecco le più importanti caratteristiche, riscontrabili in ogni modello:

- Struttura portante in legno massello.
- Molleggio a molle biconiche in acciaio e cinghie elastiche di supporto e tenuta indeformabili.
- Imbottiture di sostegno interne e braccioli in poliuretano a quote e densità differenziate.
- Cuscini schienale e seduta dotati di fodera bianca in cotone 100% e imbottitura a settori separati in piuma naturale, con inserto di sostegno in poliuretano oppure in poliuretano indeformabile a quote differenziate.

La piuma utilizzata è garantita da Assopiuma.



-Ampia scelta di rivestimenti in tessuto o pelle disponibili a piacere nel ricco campionario o, eventualmente, con materiali forniti dal cliente.

A seguito di eventuali aggiornamenti tecnico-produttivi la Pigoli Salotti si riserva la facoltà di modificare le caratteristiche tecniche degli articoli di sua produzione e di apportare, senza alcun preavviso, variazioni nell'assortimento dei prodotti.

Una tolleranza del 3% sulle misure indicate è da considerarsi accettata.

Technical specifications

Any original product processing by Pigoli Salotti complies with the highest possible quality standards, unique and typical of any traditional handicraft processing technique: only exclusively selected raw materials are used, guaranteed by a consistent technological reliability, to last in time.

The leading features in any model mainly are:

- A self-standing solid wood structure.
- Biconical steel springs and supporting and tight belts, which keep their shape in time.
- Internal upholstery and polyurethane foam arms in different thickness and density.
- Back and seat cushions covered with a 100% white cotton lining. Natural down with separate section padding with supporting insert in polyurethane foam or in shape-retaining multi-density polyurethane foam.

Down guaranteed by Assopiuma.
-A wide range of fabric or leather covering, in the many materials available in the company collection or possibly any customer own material.

Pigoli Salotti reserves the right of modifying the technical characteristics of its production item and introducing changes in its products stock without notice as a result of a possible technical and production updating. A 3% allowance with respect the measurements is considered acceptable.



Schemi & Misure

Agatha capitonnè_2

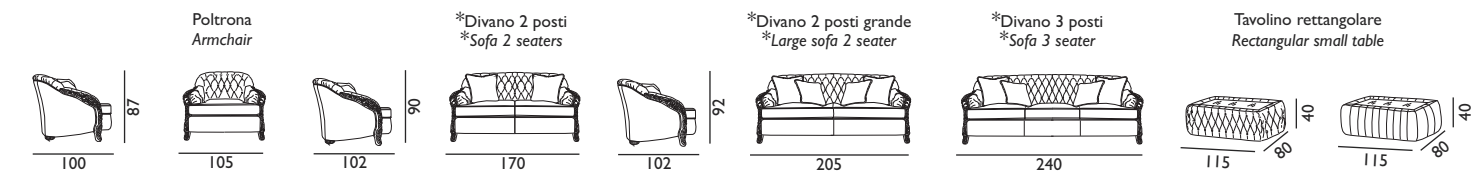

Il modello Agatha è disponibile anche in versione **NON capitonnè**.

The Agatha model is also available in the **NOT pinch quilted** version.

Airone_16

I terminali e la dormeuse del modello **Airone** sono disponibili in versione DX o SX.
Ending elements and dormeuse for model **Airone** are available in left or right version.



Il modello Airone è disponibile anche in versione **capitonnè**.

The Airone model is also available in the **pinch quilted** version.

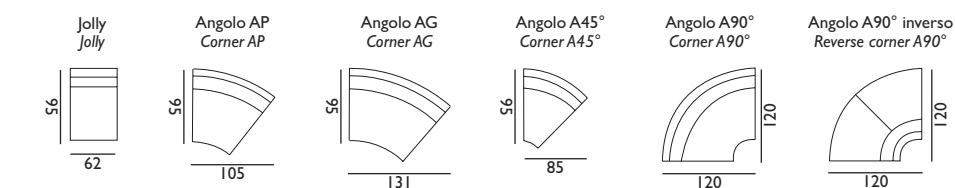
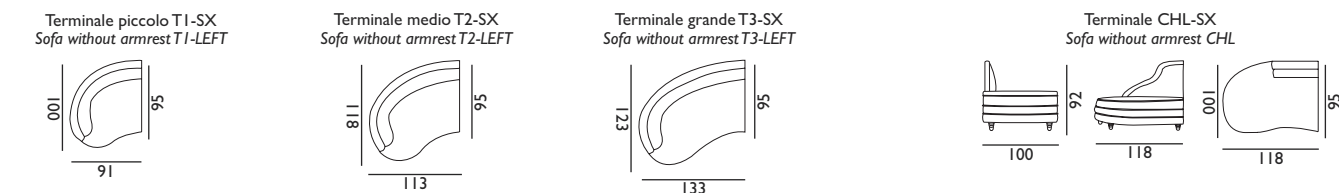
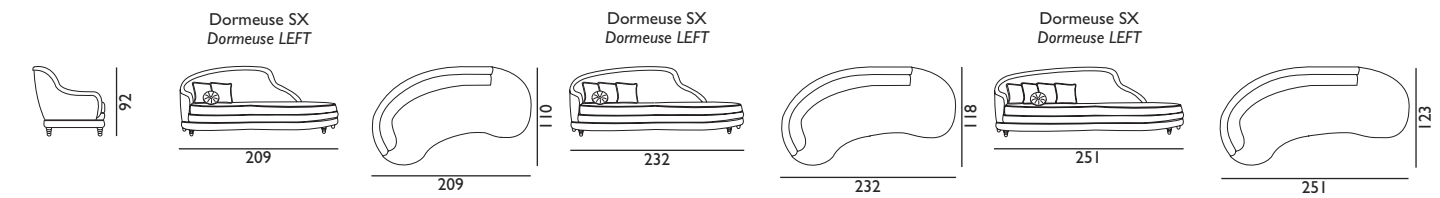
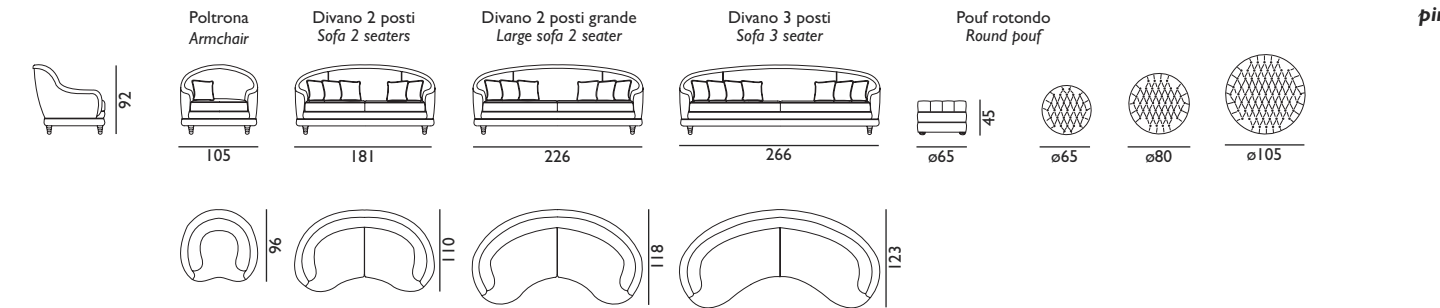

Composizione pagina 20/21
Page 20/21 composition

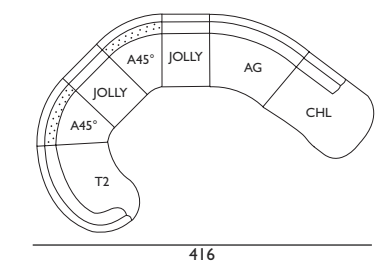

Composizione pagina 16/17
Page 16/17 composition

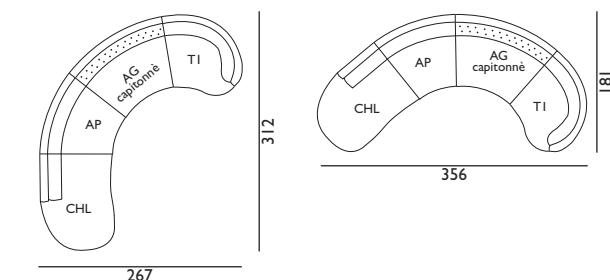

Alice_9/29

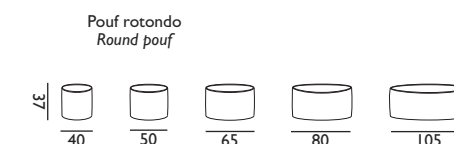

Ambassador bracciolo capitonné_32

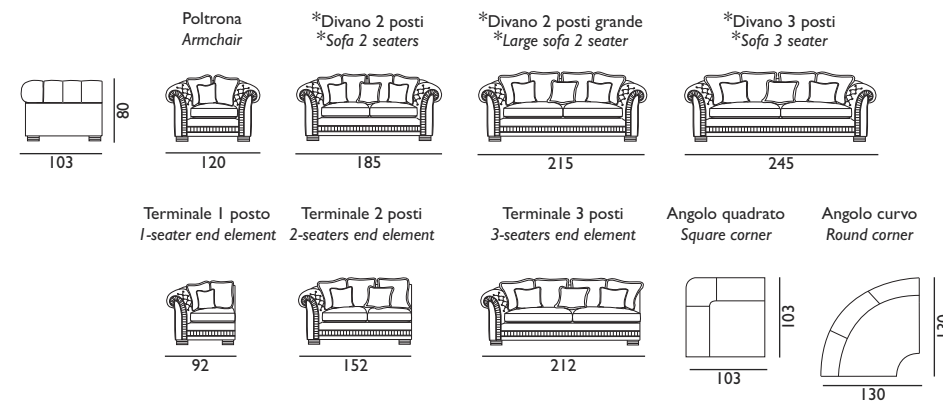

Il modello Ambassador è disponibile anche in versione con bracciolo **NON capitonné**.

The Ambassador model is also available in the **NOT pinch quilted** arm version.

Ducale_10

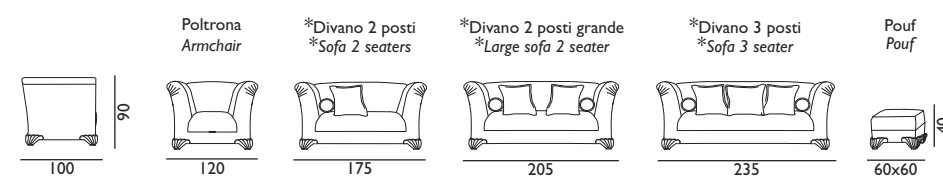

Etoile_36

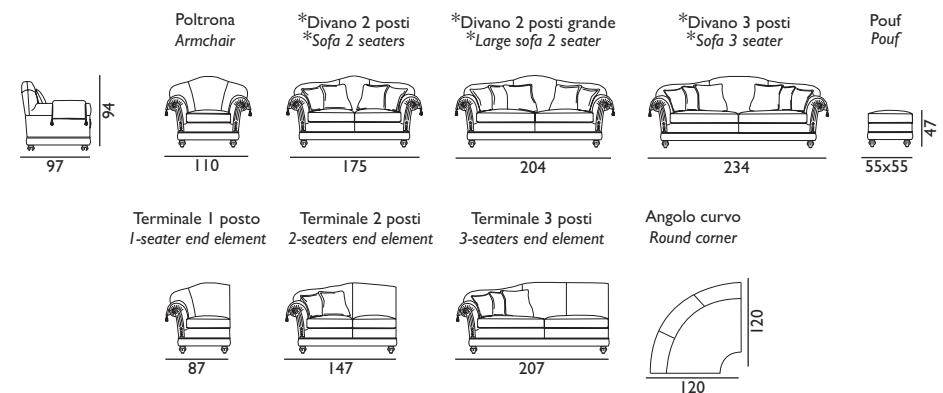

Il modello Etoile è disponibile anche in versione **capitonné**.

The Etoile model is also available in the **pinch quilted** version.

Etoile-ring capitonné_34

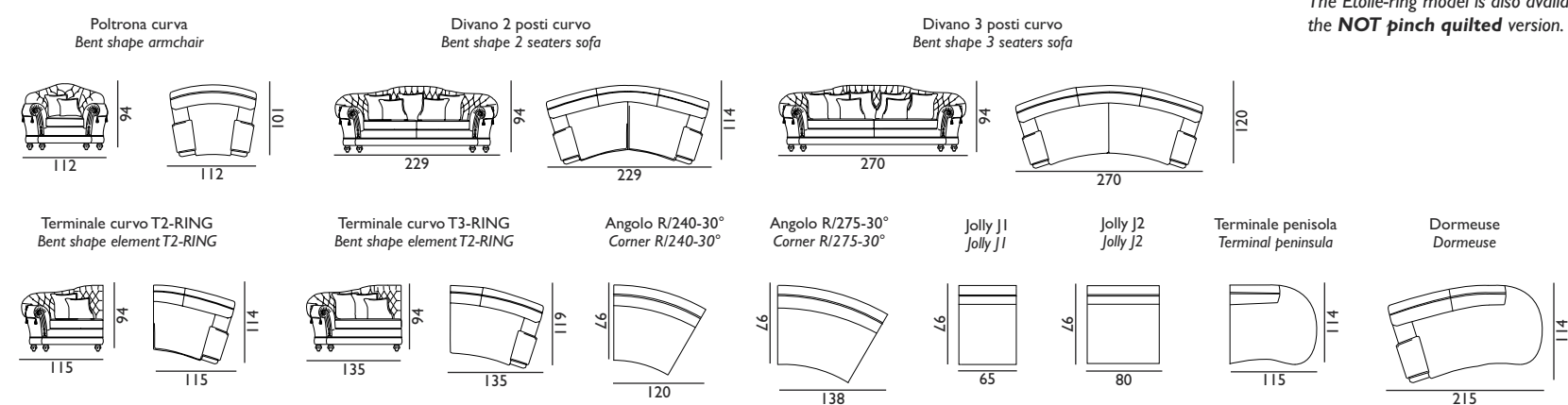

Il modello Etoile-ring è disponibile anche in versione **NON capitonné**.

The Etoile-ring model is also available in the **NOT pinch quilted** version.

Eva_24

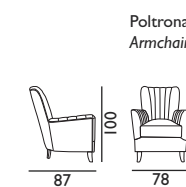

Glicine_42

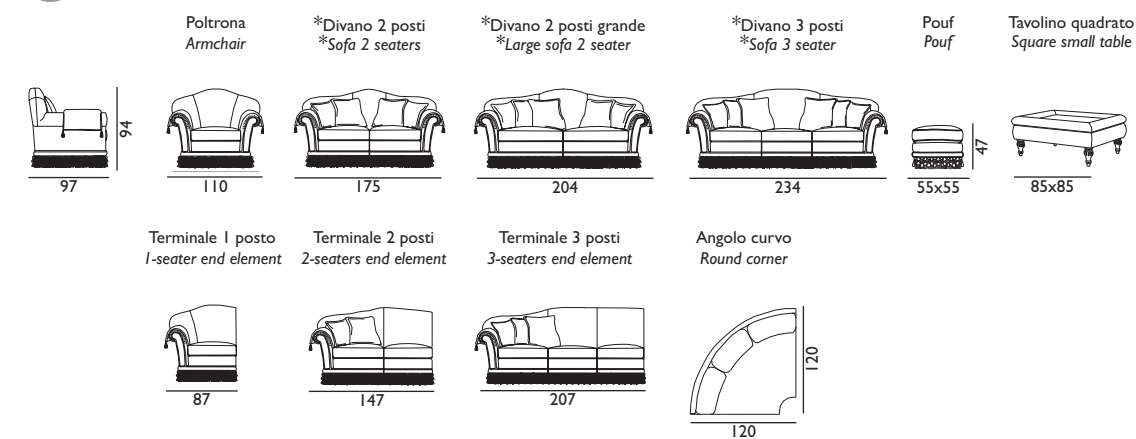

Il modello Glicine è disponibile anche in versione **capitonné**.

The Glicine model is also available in the **pinch quilted** version.



Il modello Glicine è disponibile anche in versione **con piede a vista**.

The Glicine model is also available with **visible foot** version.

Glicine with special bed

Divano 2 posti grande Large sofa 2 seater 240
 Divano 2 posti grande Large sofa 2 seater 202

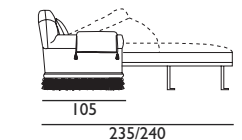

Glicine-ring_46

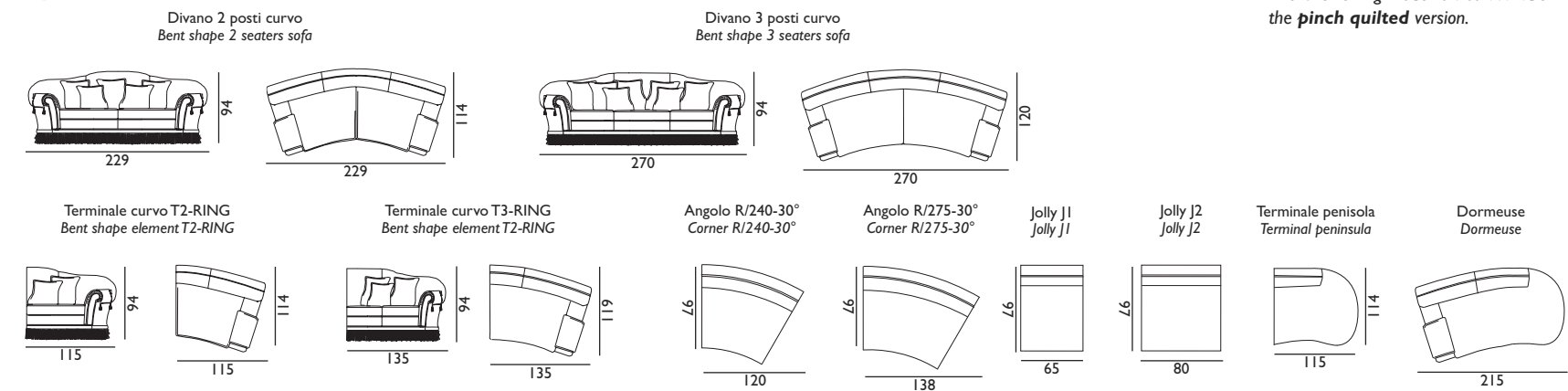

Il modello Glicine-ring è disponibile anche in versione **capitonné**.

The Glicine-ring model is also available in the **pinch quilted** version.

Hermitage_28



Il modello Hermitage è disponibile anche con piede in **ottone**.

The Hermitage model is also available with a **brass** foot.

Ibisco

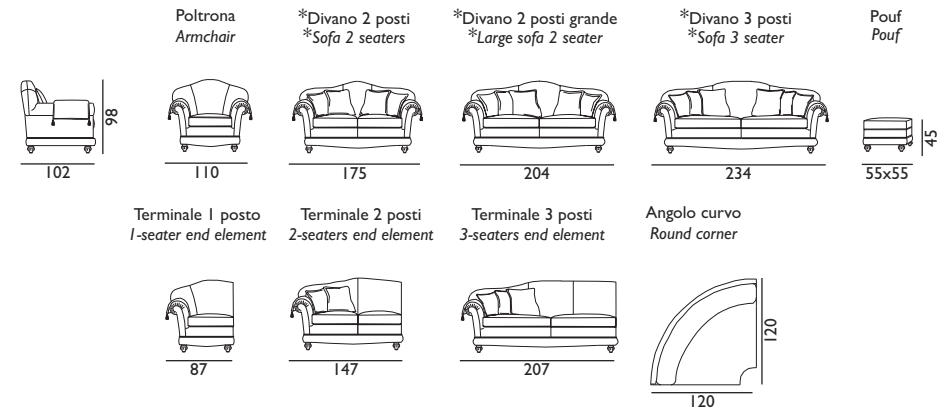

Il modello Ibisco è disponibile anche in versione **capitonné**.

The Ibisco model is also available in the **pinch quilted** version.

Morfeo capitonné_48

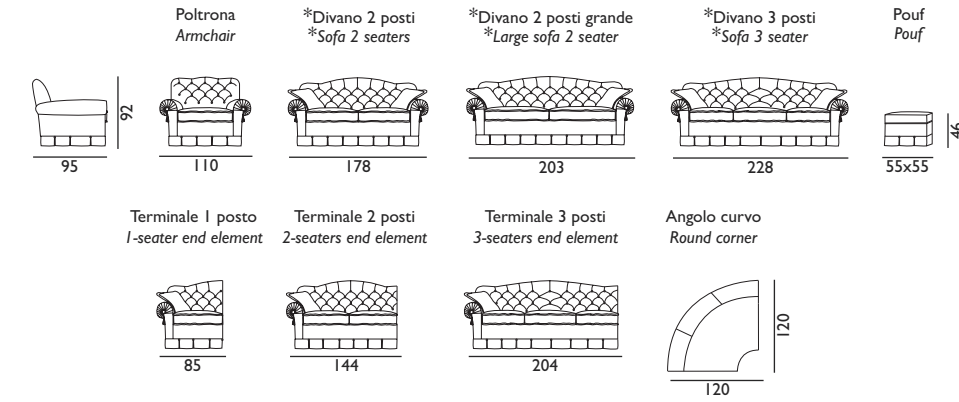

Il modello Morfeo è disponibile anche in versione **NON capitonné**.

The SMorfeo model is also available in the **NOT pinch quilted** version.

Ibisco-ring_50

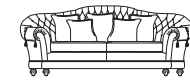
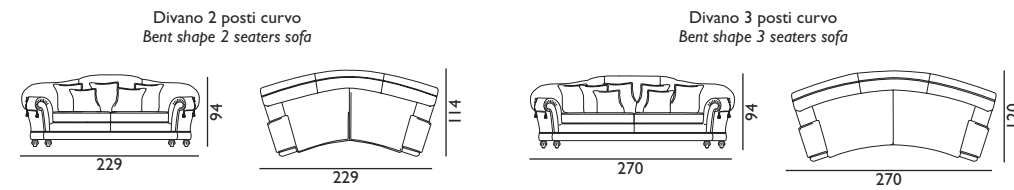

Il modello Ibisco-ring è disponibile anche in versione **capitonné**.

The Ibisco-ring model is also available in the **pinch quilted** version.

Nives_53

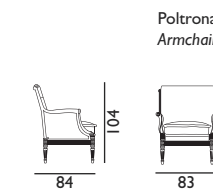

Nives capitonné_52

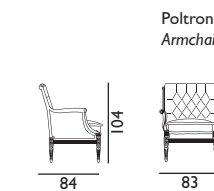

Kyoto_12

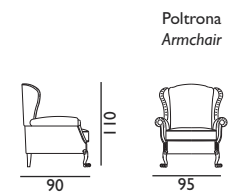

Kyoto capitonné_14

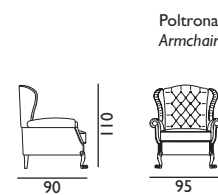

Rodi_12

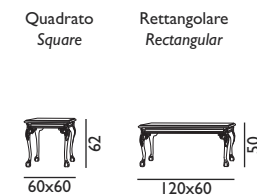

Raphael_8

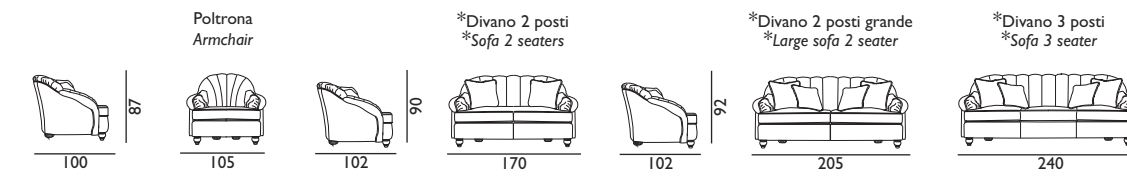

Il modello Raphael è disponibile anche in versione **capitonné**.

The Raphael model is also available in the **pinch quilted** version.

Marlene_26

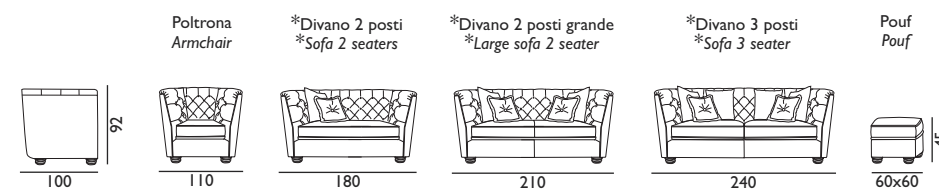

Segesta capitonné_38

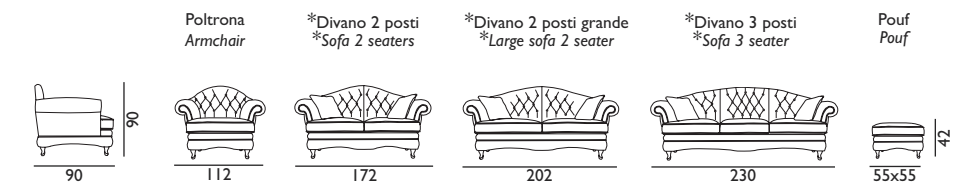

Il modello Segesta è disponibile anche in versione **NON capitonné**.

The Segesta model is also available in the **NOT pinch quilted** version.



Il modello Segesta è disponibile anche con piede **LUXURY**.

The Segesta model is also available with a **LUXURY** foot.

Marlene-ring_22

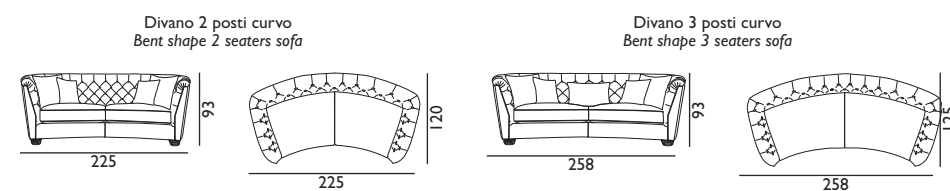

Kos tavolino

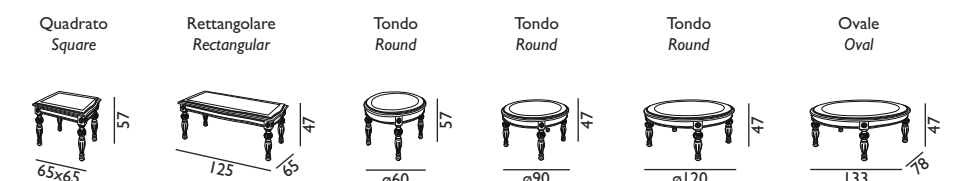

Il modello Kos è disponibile in versione **con piano marmo o con piano cristallo**.

The Kos model is available in **marble or glass top** version.

* Disponibile anche in versione trasformabile a letto, senza modifiche nell'estetica.

* Also available in the bed version, without aesthetic changes.

Finiture_Finishing



LUC 01
Noce
Walnut



LUC 02
Noce scuro
Dark walnut



LUC 10
Noce e oro
Walnut and gold



LUC 03
Ciliegio
Cherry



LUC 11
Decapè chiaro
Light pickled finish



LUC 12
Decapè scuro
Dark pickled finish



LUC 15
Wengè
Wengè

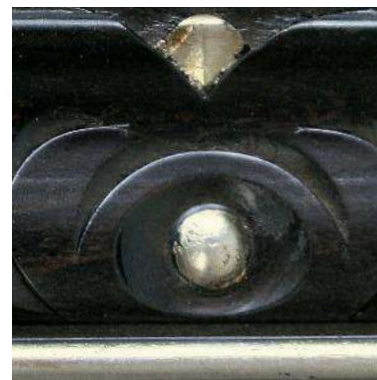

LUC 18
Wengè e argento
Wengè and silver



LUC 19
Mogano
Mahogany

Finiture_Finishing



LAC 20
Argento foglia
Silver leaf



LAC 22
Argento Antico
Patinated silver



LAC 24
Argento Mecca
Mecca's silver



LAC 25
Argento spugnato
Sponged silver



LAC 30
Oro foglia
Gold leaf



LAC 31
Oro patinato
Patinated gold



LAC 45
Oro sbiancato
White gold



LAC 50
Bronzo
Bronze



LAC 40
Avorio
Ivory



LAC 42
Avorio e oro
Ivory and gold



LAC 44
Avorio e argento
Ivory and silver



Laccato RAL
RAL lacquered

I riferimenti colore sono puramente indicativi.
The colours samples are only indicative.

Chiarissima.it

www.pigoli.com